

Entry Doors

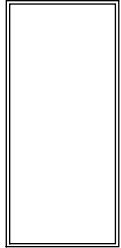

Panel Styles

SP6-2



FLUSH

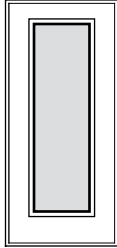

FULL LITE

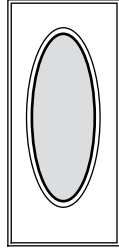

OVAL

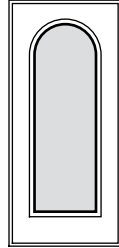

FULL
SPRINGLINE

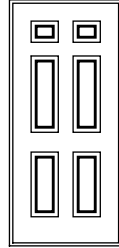

6-PANEL

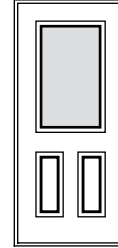

HALF LITE

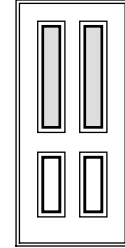

TWIN
HALF LITE

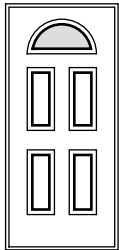

4-PANEL
CIRCLEHEAD

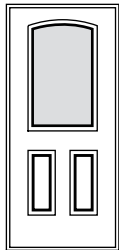

HALF
ARCH HEAD

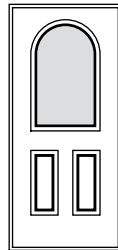

HALF
SPRINGLINE

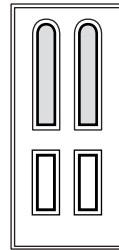

TWIN HALF
SPRINGLINE

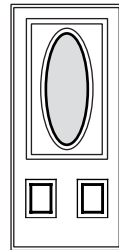

3-PANEL
OVAL

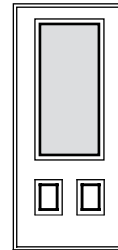

3/4 LITE

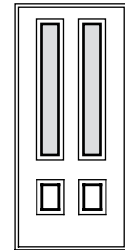

TWIN 3/4 LITE

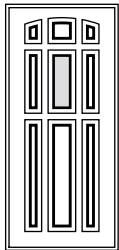

9-PANEL
CENTER LITE

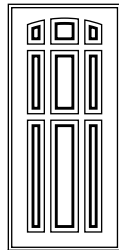

9-PANEL

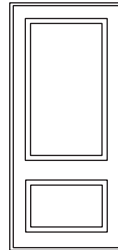

EUROPEAN
2-PANEL

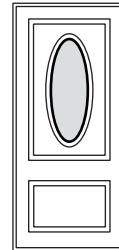

EUROPEAN
2-PANEL OVAL

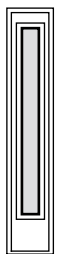

FULL LITE



HALF LITE



3/4 LITE



HALF
SPRINGLINE



DIRECT SET
GLASS

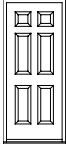

Entry Doors



Design Data

SP6-4

Clad Doors

	Door Size	Clear Opening Dim. @ 180			Clear Opening Dim. @ 90		
		Width	Height	Total Sq. Ft.	Width	Height	Total Sq. Ft.
Inswing	28" x 68"	30-7/8"	78-7/8"	16.9	29-1/8"	78-7/8"	16.0
	28" x 70"	30-7/8"	82-7/8"	17.8	29-1/8"	82-7/8"	16.8
	28" x 80"	30-7/8"	94-7/8"	20.3	29-1/8"	94-7/8"	19.2
	30" x 68"	34-7/8"	78-7/8"	19.1	33-1/8"	78-7/8"	18.2
	30" x 68" ADA	34-7/8"	78-7/8"	19.1	33-1/8"	78-7/8"	18.2
	30" x 70"	34-7/8"	82-7/8"	20.1	33-1/8"	82-7/8"	19.1
	30" x 70" ADA	34-7/8"	82-7/8"	20.1	33-1/8"	82-7/8"	19.1
	30" x 80"	34-7/8"	94-7/8"	23.0	33-1/8"	94-7/8"	21.8
	30" x 80" ADA	34-7/8"	94-7/8"	23.0	33-1/8"	94-7/8"	21.8

Wood Doors

	Door Size	Clear Opening Dim. @ 180			Clear Opening Dim. @ 90		
		Width	Height	Total Sq. Ft.	Width	Height	Total Sq. Ft.
Inswing	28" x 68"	31-1/16"	79-1/16"	17.0	29-1/4"	79"	16.0
	28" x 70"	31-1/16"	83-1/16"	17.9	29-1/4"	83"	16.9
	28" x 80"	31-1/16"	95-1/16"	20.5	29-1/4"	95"	19.3
	30" x 68"	35-1/16"	79-1/16"	19.2	33-1/4"	79"	18.2
	30" x 68" ADA	35-1/16"	79-1/16"	19.3	33-1/4"	79-1/16"	18.2
	30" x 70"	35-1/16"	83-1/16"	20.2	33-1/4"	83"	19.2
	30" x 70" ADA	35-1/16"	83-1/16"	20.2	33-1/4"	83-1/16"	19.2
	30" x 80"	35-1/16"	95-1/16"	23.1	33-1/4"	95"	21.9
	30" x 80" ADA	35-1/16"	95-1/16"	23.2	33-1/4"	95-1/16"	21.9
Out-Swing	28" x 68"	31-1/16"	78-1/16"	16.8	29-1/4"	78-1/16"	15.8
	28" x 70"	31-1/16"	82-1/16"	17.7	29-1/4"	82-1/16"	16.7
	28" x 80"	31-1/16"	94-1/16"	20.3	29-1/4"	94-1/16"	19.1
	30" x 68"	35-1/16"	78-1/16"	19.0	33-1/4"	78-1/16"	18.0
	30" x 70"	35-1/16"	82-1/16"	20.0	33-1/4"	82-1/16"	18.9
	30" x 80"	35-1/16"	94-1/16"	22.9	33-1/4"	94-1/16"	21.7

All dimensions are approximate to the nearest 1/16"
 To convert areas to square meters (m²), multiply square feet by 0.0929

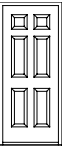

Decorative Glass Collections

SP6-5



Athena Collection™

- An elegant contemporary design combining private, colorless textured glass with exclusive nickel-plated came
- Features custom-created, hand-cut obscure and polished clear bevels
- Includes Reedlite and Frosted Satin glass



Isabella Collection™

- A contemporary geometric design featuring privacy-oriented colorless textured and pearl art glass, straight lines of solid roll-formed brass came
- Features custom-created, hand-cut and -polished, multifaceted bevels
- Includes Granite, Frosted Delta and Glue Chip glass accents



Francesca Collection™

- A dazzling beveled glass centerpiece and border, surrounded with obscure, colorless textured art glass, assembled in solid roll-formed brass came
- Features 35mm 24% lead crystal jewels
- Includes Ripple and Glue Chip glass



Juliet Collection™

- A stunning combination of sparkling yet private, colorless textured art glass, wrapped with black patina zinc coming.
- Features 35mm and 25mm 24% lead crystal jewels
- Includes Frosted Delta, Ripple, Chord and Baroque™ glass

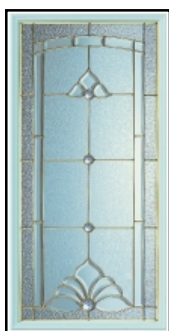

Guinevere Collection™

- Lovely beveled glass clusters with border, obscure colorless textured art glass, assembled with solid roll-formed brass came
- Features 50mm and 35mm 24% lead crystal jewels
- Includes Glue Chip and Sparkle glass



Victoria Collection™

- A delightful beveled-glass feature piece with pencil-beveled border highlights, a fabulous soft swirling gray Baroque™ glass background and colorless Ripple glass border, assembled with solid roll-formed brass came
- Features highlights of hand-polished, multifaceted diamond bevels
- Includes Ripple and gray Baroque glass

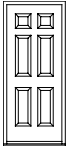

Entry Doors



Carbonite™ Panel Style, Size and Glazing Options

SP6-6

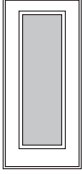
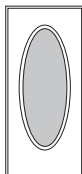
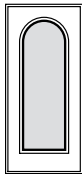
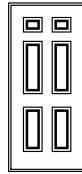
Panel Style	Door Size	Reference Glass Size	Glass Type								Muntins		
			Juliet	Francesca	Victoria	Guinevere	Athena	Isabella	Clear	Low-E	Grilles-Between-The-Glass		
Flush 	2'8 x 6'8 3'0 x 6'8	NA NA											
Full Lite 	2'8 x 6'8 3'0 x 6'8 2'8 x 8'0 3'0 x 8'0	22 x 64 22 x 64 22 x 80 22 x 80		●	●	●	●	●	●	●	●	●	●
Oval 	2'8 x 6'8 3'0 x 6'8	20 x 56 20 x 56		●	●						●		●
Full Springline 	2'8 x 6'8 3'0 x 6'8	22 x 64 22 x 64	●	●		●					●		●
6-Panel 	2'8 x 6'8 3'0 x 6'8 2'8 x 8'0 3'0 x 8'0	NA NA NA NA											



Entry Doors



Carbonite™ Panel Style, Size and Glazing Options

SP6-7

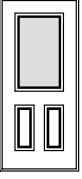
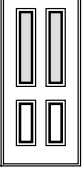
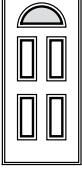
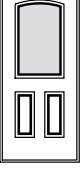
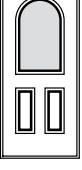
Panel Style	Door Size	Reference Glass Size	Glass Type									Muntins		
			Juliet	Francesca	Victoria	Guinevere	Athena	Isabella	Clear	Low-E	Grilles-	Between-	The-Glass	
Half Lite 	2'8 x 6'8	22 x 36		●	●		●	●	●	●	●	●	●	
	3'0 x 6'8	22 x 36		●	●		●	●	●	●	●	●	●	
	2'8 x 8'0	22 x 48	●	●	●	●	●	●	●	●	●	●	●	
	3'0 x 8'0	22 x 48	●	●	●	●	●	●	●	●	●	●	●	
Twin Half Lite 	2'8 x 6'8	8 x 36			●				●		●			
	3'0 x 6'8	8 x 36			●				●		●			
4-Panel (CH) 	2'8 x 6'8	22 x 10			●	●			●		●	●		
	3'0 x 6'8	22 x 10			●	●			●		●	●		
Half Lite Arch Head 	2'8 x 6'8	22 x 38	●			●					●			
	3'0 x 6'8	22 x 38	●			●					●			
Half Lite Springline 	2'8 x 6'8	22 x 36	●			●					●			
	3'0 x 6'8	22 x 36	●			●					●			

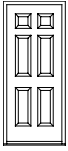

Entry Doors



Carbonite™ Panel Style, Size and Glazing Options

SP6-8

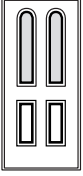
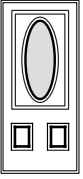
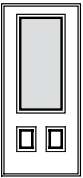
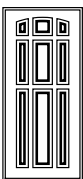
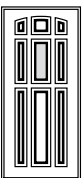
Panel Style	Door Size	Reference Glass Size	Glass Type								Muntins	
			Juliet	Francesca	Victoria	Guinevere	Athena	Isabella	Clear	Low-E	Grilles- Between- The-Glass	
Twin Half Springline 	2'8 x 6'8 3'0 x 6'8	8 x 36 8 x 36			● ●	● ●					● ●	
3-Panel Oval 	2'8 x 6'8 3'0 x 6'8	14 x 37 14 x 37		● ●	● ●				● ●		● ●	
3/4 Lite 	2'8 x 6'8 3'0 x 6'8	22 x 48 22 x 48	● ●	● ●	● ●	● ●	● ●	● ●			● ●	● ●
9-Panel 	2'8 x 6'8 3'0 x 6'8	NA NA										
9-Panel Center Lite 	2'8 x 6'8 3'0 x 6'8	7.5 x 18.5 7.5 x 18.5			● ●			● ●	● ●		● ●	



Entry Doors



Carbonite™ Panel Style, Size and Glazing Options

SP6-9

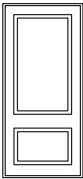
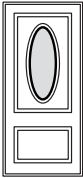
Panel Style	Door Size	Reference Glass Size	Glass Type								
			Juliet	Francesca	Victoria	Guinevere	Athena	Isabella	Clear	Low-E	
European 2-Panel* 	2'8 x 6'8 3'0 x 6'8	NA NA									
European 2-Panel Oval* 	2'8 x 6'8 3'0 x 6'8	12 x 34 12 x 34		● ●	● ●				● ●		● ●

* Walnut Grain

Sidelights

Shape	Door Size	Reference Glass Size	Glass Type								Muntins	
			Juliet	Francesca	Victoria	Guinevere	Athena	Isabella	Clear	Low-E	Grilles- Between- The-Glass	
Full Lite Sidelight 	1'0 x 6'6	7 x 64	●	●	●	●	●	●	●	●	●	●
	1'2 x 6'6	7 x 64	●	●	●	●	●	●	●	●	●	●
	1'0 x 6'8	7 x 64	●	●	●	●	●	●	●	●	●	●
	1'2 x 6'8	7 x 64	●	●	●	●	●	●	●	●	●	●

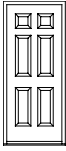





Entry Doors



Carbonite™ Panel Style, Size and Glazing Options

SP6-10

Sidelights

Shape	Door Size	Reference Glass Size	Door Type								Muntins	
			Juliet	Francesca	Victoria	Guinevere	Athena	Isabella	Clear	Low-E	Grilles-Between-The-Glass	
Full Lite Sidelight* 	1'0 x 6'8	7 x 64	●	●	●	●	●	●	●	●	●	
	1'2 x 6'8	7 x 64	●	●	●	●	●	●	●	●	●	
3/4 Lite Sidelight 	1'0 x 6'8	8 x 48	●	●	●	●	●	●		●	●	
	1'2 x 6'8	8 x 48	●	●	●	●	●	●		●	●	
Half Lite Sidelight 	1'0 x 6'8	8 x 36	●	●	●	●	●	●	●	●	●	
	1'2 x 6'8	8 x 36	●	●	●	●	●	●	●	●	●	
	1'0 x 8'0	8 x 48	●	●	●	●	●	●	●	●	●	
	1'2 x 8'0	8 x 48	●	●	●	●	●	●	●	●	●	
Half Springline Sidelight 	1'0 x 6'8	8 x 36			●	●				●		
	1'2 x 6'8	8 x 36			●	●				●		

* Walnut Grain

Direct Set Sidelight

	1'0 x 6'8								●	●	●
	1'2 x 6'8								●	●	●
	1'0 x 7'0								●	●	●
	1'2 x 7'0								●	●	●
	1'0 x 8'0								●	●	●
	1'2 x 8'0								●	●	●





Entry Doors



Steel Panel Style, Size and Glazing Options

SP6-11

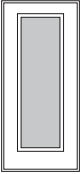
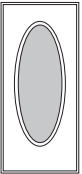
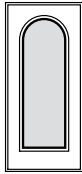
Shape	Door Size	Reference Glass Size	Glass Type								Muntins	
			Juliet	Francesca	Victoria	Guinevere	Athena	Isabella	Clear	Low-E	Grilles-Between-The-Glass	
Flush 	2'8 x 6'8	NA										
	3'0 x 6'8	NA										
	2'8 x 7'0	NA										
	3'0 x 7'0	NA										
	2'8 x 8'0	NA										
	3'0 x 8'0	NA										
Flush Utility 	2'8 x 6'8	NA										
	3'0 x 6'8	NA										
Full Lite 	2'8 x 6'8	22 x 64		●	●	●	●	●	●	●	●	●
	3'0 x 6'8	22 x 64		●	●	●	●	●	●	●	●	●
	2'8 x 7'0	22 x 64		●	●	●	●	●	●	●	●	●
	3'0 x 7'0	22 x 64		●	●	●	●	●	●	●	●	●
	2'8 x 8'0	22 x 80	●	●	●	●	●	●	●	●	●	●
	3'0 x 8'0	22 x 80	●	●	●	●	●	●	●	●	●	●
Oval 	2'8 x 6'8	20 x 56		●	●					●		
	3'0 x 6'8	20 x 56		●	●					●		
	2'8 x 7'0	20 x 56		●	●					●		
	3'0 x 7'0	20 x 56		●	●					●		
Full Springline 	2'8 x 6'8	22 x 64	●	●		●				●		
	3'0 x 6'8	22 x 64	●	●		●				●		
	2'8 x 7'0	22 x 64	●	●		●				●		
	3'0 x 7'0	22 x 64	●	●		●				●		

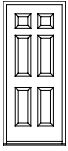

Entry Doors



Steel Panel Style, Size and Glazing Options

SP6-12

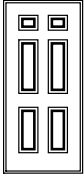
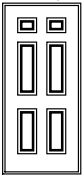
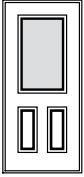
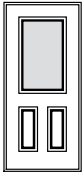
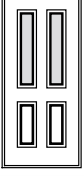
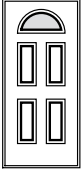
Shape	Door Size	Reference Glass Size	Glass Type									Muntins	
			Juliet	Francesca	Victoria	Guinevere	Athena	Isabella	Clear	Low-E	Grilles-Between-The-Glass		
6-Panel 	2'8 x 6'8	NA											
	3'0 x 6'8	NA											
	2'8 x 7'0	NA											
	3'0 x 7'0	NA											
6-Panel Utility 	2'8 x 6'8	NA											
	3'0 x 6'8	NA											
Half Lite 	2'8 x 6'8	22 x 36		●	●		●	●	●	●	●		
	3'0 x 6'8	22 x 36		●	●		●	●	●	●	●		
	2'8 x 7'0	22 x 36		●	●		●	●	●	●	●		
	3'0 x 7'0	22 x 36		●	●		●	●	●	●	●		
Half Lite Utility 	2'8 x 6'8	22 x 36						●		●			
	3'0 x 6'8	22 x 36						●		●			
Twin Half Lite 	2'8 x 6'8	8 x 36			●			●	●	●			
	3'0 x 6'8	8 x 36			●			●	●	●			
	2'8 x 7'0	8 x 36			●			●	●	●			
	3'0 x 7'0	8 x 36			●			●	●	●			
4-Panel (CH) 	2'8 x 6'8	22 x 10			●	●		●	●	●	●		
	3'0 x 6'8	22 x 10			●	●		●	●	●	●		
	2'8 x 7'0	22 x 10			●	●		●	●	●	●		
	3'0 x 7'0	22 x 10			●	●		●	●	●	●		



Entry Doors

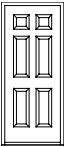

Steel Panel Style, Size and Glazing Options

SP6-13

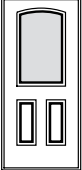
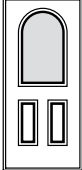
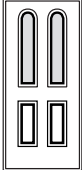
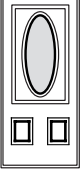
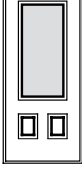
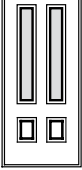
Shape	Door Size	Reference Glass Size	Glass Type								Muntins
			Juliet	Francesca	Victoria	Guinevere	Athena	Isabella	Clear	Low-E	Grilles-Between-The-Glass
Half Lite Arch Head 	2'8 x 6'8	22 x 38	●			●				●	
	3'0 x 6'8	22 x 38	●			●				●	
	2'8 x 7'0	22 x 38	●			●				●	
	3'0 x 7'0	22 x 38	●			●				●	
Half Lite Springline 	2'8 x 6'8	22 x 36	●			●				●	
	3'0 x 6'8	22 x 36	●			●				●	
	2'8 x 7'0	22 x 36	●			●				●	
	3'0 x 7'0	22 x 36	●			●				●	
Twin Half Springline 	2'8 x 6'8	8 x 36			●	●				●	
	3'0 x 6'8	8 x 36			●	●				●	
	2'8 x 7'0	8 x 36			●	●				●	
	3'0 x 7'0	8 x 36			●	●				●	
3-Panel Oval 	2'8 x 6'8	14 x 37		●	●			●		●	
	3'0 x 6'8	14 x 37		●	●			●		●	
3/4 Lite 	2'8 x 6'8	22 x 48	●	●	●	●	●	●		●	●
	3'0 x 6'8	22 x 48	●	●	●	●	●	●		●	●
	2'8 x 7'0	22 x 48	●	●	●	●	●	●		●	●
	3'0 x 7'0	22 x 48	●	●	●	●	●	●		●	●
Twin 3/4 Lite 	2'8 x 6'8	8 x 48			●			●		●	
	3'0 x 6'8	8 x 48			●			●		●	
	2'8 x 7'0	8 x 48			●			●		●	
	3'0 x 7'0	8 x 48			●			●		●	

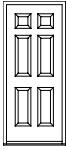

Entry Doors



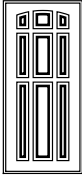
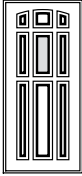

Steel Panel Style, Size and Glazing Options

SP6-14

Shape	Door Size	Reference Glass Size	Glass Type									Muntins		
			Juliet	Francesca	Victoria	Guinevere	Athena	Isabella	Clear	Low-E	Grilles-Between-The-Glass			
9-Panel 	2'8 x 6'8 3'0 x 6'8	NA NA												
9-Panel Center Lite 	2'8 x 6'8 3'0 x 6'8	7.5 x 18.5 7.5 x 18.5			● ●			● ●	● ●			● ●		

Sidelights

Shape	Door Size	Reference Glass Size	Glass Type									Muntins		
			Juliet	Francesca	Victoria	Guinevere	Athena	Isabella	Clear	Low-E	Grilles-Between-The-Glass			
Full Lite Sidelight 	1'0 x 6'8 1'2 x 6'8 1'0 x 7'0 1'2 x 7'0 1'0 x 8'0 1'2 x 8'0	7 x 64 7 x 64 7 x 64 7 x 64 8 x 80 8 x 80	● ● ● ● ● ●	● ● ● ● ● ●	● ● ● ● ● ●	● ● ● ● ● ●	● ● ● ● ● ●	● ● ● ● ● ●	● ● ● ● ● ●	● ● ● ● ● ●	● ● ● ● ● ●	● ● ● ● ● ●	● ● ● ● ● ●	● ● ● ● ● ●
3/4 Lite Sidelight 	1'0 x 6'8 1'2 x 6'8 1'0 x 7'0 1'2 x 7'0	8 x 48 8 x 48 8 x 48 8 x 48	● ● ● ●	● ● ● ●	● ● ● ●	● ● ● ●	● ● ● ●	● ● ● ●	● ● ● ●	● ● ● ●	● ● ● ●	● ● ● ●	● ● ● ●	● ● ● ●



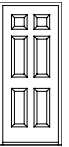

Entry Doors



Steel Panel Style, Size and Glazing Options

SP6-15

Sidelights

Shape	Door Size	Reference Glass Size	Glass Type								Muntins	
			Juliet	Francesca	Victoria	Guinevere	Athena	Isabella	Clear	Low-E	Grilles-Between-Glass	The-Glass
	1'0 x 6'8	8 x 36	●	●	●	●	●	●	●	●	●	●
	1'2 x 6'8	8 x 36	●	●	●	●	●	●	●	●	●	●
	1'0 x 7'0	8 x 36	●	●	●	●	●	●	●	●	●	●
	1'2 x 7'0	8 x 36	●	●	●	●	●	●	●	●	●	●
	1'0 x 6'8	8 x 36			●	●				●		
	1'2 x 6'8	8 x 36			●	●				●		
	1'0 x 7'0	8 x 36			●	●				●		
	1'2 x 7'0	8 x 36			●	●				●		

Direct Set Sidelight

	1'0 x 6'8								●	●	●
	1'2 x 6'8								●	●	●
	1'0 x 7'0								●	●	●
	1'2 x 7'0								●	●	●
	1'0 x 8'0								●	●	●
	1'2 x 8'0								●	●	●

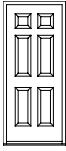







Entry Doors

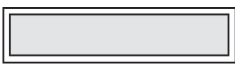

Transoms - Shape, Size and Glazing Options

SP6-16

Shape	Frame Size (Width)	Glass Type								Muntins		
		Juliet	Francesca	Victoria	Guinevere	Athena	Isabella	Clear	Low-E	Grilles-	Between-	The-Glass
Clad Rectangular 	33-1/2	●	●	●	●	●	●	●	●	●	●	●
	37-1/2	●	●	●	●	●	●	●	●	●	●	●
	60-1/2	●	●	●	●	●	●	●	●	●	●	●
	64-1/2	●	●	●	●	●	●	●	●	●	●	●
	68-1/2	●	●	●	●	●	●	●	●	●	●	●
Clad Half Circle 	33-1/2	●	●	●	●			●	●			
	37-1/2	●	●	●	●			●	●			
	60-1/2	●	●	●	●			●	●			
	64-1/2	●	●	●	●			●	●			
	68-1/2	●	●	●	●			●	●			
Clad Elliptical 	60-1/2		●	●	●			●	●			
	64-1/2		●	●	●			●	●			
	68-1/2		●	●	●			●	●			
Clad Arch Head 	33-1/2	●	●	●	●	●	●	●	●			
	37-1/2	●	●	●	●	●	●	●	●			
	60-1/2	●	●	●	●	●	●	●	●			
	64-1/2	●	●	●	●	●	●	●	●			
	68-1/2	●	●	●	●	●	●	●	●			
Wood Rectangular 	33-1/2							●	●			
	37-1/2							●	●			
	60-1/2							●	●			
	64-1/2							●	●			
	68-1/2							●	●			
Wood Half Circle 	33-1/2							●	●			
	37-1/2							●	●			
	60-1/2							●	●			
	64-1/2							●	●			
	68-1/2							●	●			



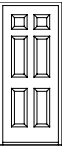

Entry Doors



Transoms - Shape, Size and Glazing Options

SP6-17

Shape	Frame Size (Width)	Glass Type								Muntins	
		Juliet	Francesca	Victoria	Guinevere	Athena	Isabella	Clear	Low-E	Grilles-Between-The-Glass	
Wood Elliptical 	60-1/2 64-1/2 68-1/2							●	●		
Wood Arch Head 	33-1/2 37-1/2 60-1/2 64-1/2 68-1/2							●	●		

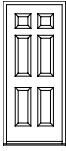

Entry Doors



Size Charts - Wood and Clad Doors

Product Code:
 SPCIE (Clad)
 SPWIE (Wood)

SP6-20

Scale 1/8" = 1' 0"

In-Swing Single Doors & Sidelights

Masonry	3' 0 1/2" (927)	3' 4 1/2" (1 029)	1' 4 1/2" (419)	1' 6 1/2" (470)
Opening	2' 10 1/4" (870)	3' 2 1/4" (972)	1' 2 1/4" (362)	1' 4 1/4" (413)
Frame	2' 9 1/2" (851)	3' 1 1/2" (953)	1' 1 1/2" (343)	1' 3 1/2" (394)
6' 11" (2 108)				
6' 10" (2 083)				
6' 9 1/2" (2 070)				
7' 3" (2 210)				
7' 2" (2 184)				
7' 1 1/2" (2 172)				
8' 3" (2 515)				
8' 2" (2 489)				
8' 1 1/2" (2 477)				

NOTES:

- Masonry dimensions include the use of Pella® Aluminum Traditional Trim (#72D6) for clad doors and brickmould for wood doors.
- All vent units are available with left or right-hand hinging. Exterior view of right-hand hinging shown.



Entry Doors



Product Code: Size Charts - Wood
 SPCOE (Clad)
 SPWOE (Wood)

Scale 1/8" = 1' 0"

SP6-21

Out-Swing Single Doors

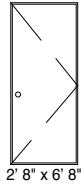
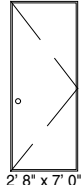
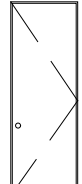
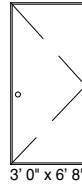
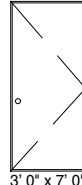
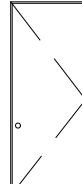
	Masonry	3' 0 1/2" (927)	3' 4 1/2" (1 029)
	Opening	2' 10 1/4" (670)	3' 2 1/4" (972)
	Frame	2' 9 1/2" (851)	3' 1 1/2" (953)
6' 10 1/2" (2 086)	6' 9 1/2" (2 070)	6' 9" (2 057)	 2' 8" x 6' 8"
7' 2 1/2" (2 197)	7' 1 1/2" (2 172)	7' 1" (2 159)	 2' 8" x 7' 0"
8' 2 1/2" (2 502)	8' 1 1/2" (2 477)	8' 1" (2 464)	 2' 8" x 8' 0"
			 3' 0" x 6' 8"
			 3' 0" x 7' 0"
			 3' 0" x 8' 0"

NOTES:

- Masonry dimensions include the use of Pella® Aluminum Traditional Trim (#72D6) for clad doors and brickmould for wood doors.
- All vent units are available with left or right-hand hinging. Exterior view of right-hand hinging shown.

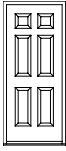

Entry Doors



Size Charts - Doors with Low Profile Sill

Product Code:
 SPCIE (Clad In-Swing)
 SPWIE (Wood In-Swing)

SP6-22

Scale 1/8" = 1' 0"

In-Swing Single Doors

	Masonry	Opening	Frame
6' 10 1/4" (2 089)	3' 4 1/2" (1 029)	3' 2 1/4" (972)	3' 1 1/2" (953)
6' 9 1/4" (2 064)			
6' 8 3/4" (2 051)			
7' 2 1/4" (2 191)			
7' 1 1/4" (2 165)			
7' 0 3/4" (2 153)			
8' 2 1/4" (2 486)			
8' 1 1/4" (2 470)			
8' 0 3/4" (2 458)			

3' 0" x 6' 8"	
3' 0" x 7' 0"	
3' 0" x 8' 0"	

NOTES:

- Masonry dimensions include the use of Pella® Aluminum Traditional Trim (#72D6) for clad doors and brickmould for wood doors.
- All vent units are available with left or right-hand hinging. Exterior view of right-hand hinging shown.



Entry Doors

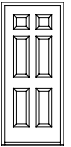

Product Code:
 SPWIE (20 Minute Fire Door)
 SPSIE (90 Minute Fire Door)

Size Charts - Fire Doors

Scale 1/8" = 1' 0"

SP6-23

20 Minute Fire Door*

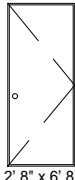
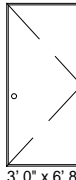
	Opening	2' 10 ¹ / ₄ " (870)	3' 2 ¹ / ₄ " (972)
	Frame	2' 9 ¹ / ₂ " (851)	3' 1 ¹ / ₂ " (953)
6' 10" (2083)	6' 9 ¹ / ₂ " (2070)		
		2' 8" x 6' 8"	3' 0" x 6' 8"

90 Minute Fire Door

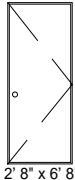
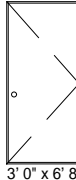
	Opening	2' 10 ¹ / ₄ " (870)	3' 2 ¹ / ₄ " (972)
	Frame	2' 9 ¹ / ₂ " (851)	3' 1 ¹ / ₂ " (953)
6' 9 ¹ / ₄ " (2064)	6' 8 ³ / ₄ " (2051)		
		2' 8" x 6' 8"	3' 0" x 6' 8"

* Available in 4-9/16", 4-11/16", 6-9/16", and 6-11/16 wall depths only.

NOTES:

- All units are available with either Flush or 6-Panel door style and are In-Swing only.
- All vent units are available with left or right-hand hinging. Exterior view of right-hand hinging shown.

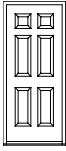

Entry Doors



Size Charts - Transoms

SP6-24

Product Code:
 SPCTR (Clad Transom)
 SPWTR (Wood Transom)
 SPCCH (Clad Circlehead)
 SPWCH (Wood Circlehead)

Scale 1/8" = 1' 0"

RECTANGULAR AND ELLIPTICAL TRANSOMS

Masonry	3' 0 1/2" (927)	3' 4 1/2" (1 029)	5' 3 1/2" (1 613)	5' 7 1/2" (1 715)	5' 11 1/2" (1 816)
Opening	2' 10 1/4" (870)	3' 2 1/4" (972)	5' 1 1/4" (1 556)	5' 5 1/4" (1 657)	5' 9 1/4" (1 759)
Frame	2' 9 1/2" (851)	3' 1 1/2" (953)	5' 0 1/2" (1 537)	5' 4 1/2" (1 638)	5' 8 1/2" (1 740)

1' 2 3/4" (375)					
1' 4 3/4" (425)					
1' 2" (356)					
1' 4" (406)					
1' 4" (406)					
			R1 = 12" R2 = 55 5/8"	R1 = 12" R2 = 65 1/4"	R1 = 12" R2 = 75 7/8"

ARCHHEAD TRANSOMS*

Masonry	3' 0 1/2" (927)
Opening	2' 10 1/4" (870)
Frame	2' 9 1/2" (851)

1' 4 7/8" (429)	
1' 4 1/8" (410)	R = 36"

Masonry	3' 4 1/2" (1 029)
Opening	3' 2 1/4" (972)
Frame	3' 1 1/2" (953)

1' 5 1/4" (438)	
1' 4 1/2" (419)	R = 42"

Masonry	5' 3 1/2" (1 613)
Opening	5' 1 1/4" (1 556)
Frame	5' 0 1/2" (1 537)

1' 9" (533)	
1' 8 1/4" (514)	R = 60"

Masonry	5' 7 1/2" (1 715)
Opening	5' 5 1/4" (1 657)
Frame	5' 4 1/2" (1 638)

1' 8 3/8" (518)	
1' 7 5/8" (498)	R = 72"

Masonry	5' 11 1/2" (1 816)
Opening	5' 9 1/4" (1 759)
Frame	5' 8 1/2" (1 740)

1' 9 1/2" (546)	
1' 8 3/4" (527)	R = 72"

* All straight legs = 1' 0" ((305))

NOTES:

- Masonry dimensions include the use of Pella® Aluminum Traditional Trim (#72D6) for clad products and brickmould for wood products.



Entry Doors



Product Code:
 SPCCH (Clad Circlehead)
 SPWCH (Wood Circlehead)

Size Charts - Transoms

Scale 1/8" = 1' 0"

SP6-25

HALF CIRCLE TRANSOMS

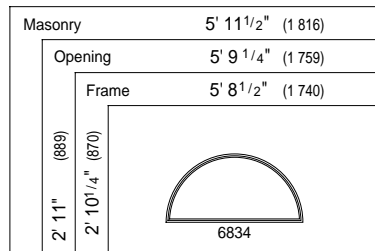
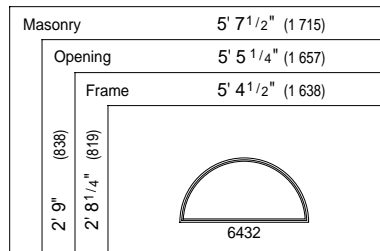
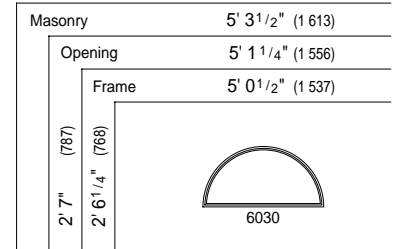
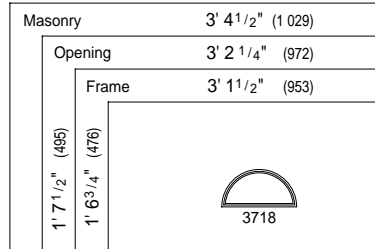
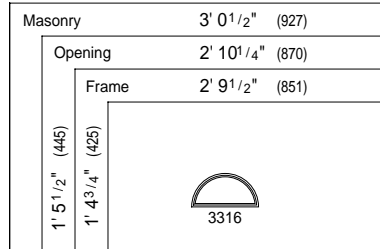

NOTES:

- Masonry dimensions include the use of Pella® Aluminum Traditional Trim (#72D6) for clad products and brickmould for wood products.

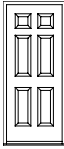

Entry Doors



Door/Sidelight Composites

Scale 1/8" = 1' 0"

SP6-26

2' 8" In-Swing Single Doors & Sidelights

Masonry	3' 0 ¹ / ₂ " (927)	4' 2" (1270)	5' 3 ¹ / ₂ " (1613)	4' 4" (1321)	5' 7 ¹ / ₂ " (1715)
Opening	2' 10 ¹ / ₄ " (870)	3' 11 ³ / ₄ " (1213)	5' 1 ¹ / ₄ " (1556)	4' 1 ³ / ₄ " (1264)	5' 5 ¹ / ₄ " (1657)
Frame	2' 9 ¹ / ₂ " (851)	3' 11" (1194)	5' 0 ¹ / ₂ " (1537)	4' 1" (1245)	5' 4 ¹ / ₂ " (1638)
6' 11" (2108)					
6' 10" (2083)		1' 0" SIDELIGHT	(2) 1' 0" SIDELIGHTS	1' 2" SIDELIGHT	(2) 1' 2" SIDELIGHTS
6' 9 ¹ / ₂ " (2070)					
7' 3" (2210)					
7' 2" (2184)		1' 0" SIDELIGHT	(2) 1' 0" SIDELIGHTS	1' 2" SIDELIGHT	(2) 1' 2" SIDELIGHTS
7' 1 ¹ / ₂ " (2172)					
8' 3" (2515)					
8' 2" (2489)		1' 0" SIDELIGHT	(2) 1' 0" SIDELIGHTS	1' 2" SIDELIGHT	(2) 1' 2" SIDELIGHTS
8' 1 ¹ / ₂ " (2477)					

NOTES:

- Masonry dimensions include the use of Pella® Aluminum Traditional Trim (#72D6) for clad products and brickmould for wood products.



Entry Doors

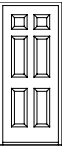

Scale 1/8" = 1' 0"

Door/Sidelight Composites

SP6-27

3' 0" In-Swing Single Doors & Sidelights

Masonry	3' 4 1/2" (1 029)	4' 6" (1 372)	5' 7 1/2" (1 715)	4' 8" (1 422)	5' 11 1/2" (1 816)
Opening	3' 2 1/4" (972)	4' 3 3/4" (1 314)	5' 5 1/4" (1 657)	4' 5 3/4" (1 365)	5' 9 1/4" (1 759)
Frame	3' 1 1/2" (953)	4' 3" (1 295)	5' 4 1/2" (1 638)	4' 5" (1 346)	5' 8 1/2" (1 740)
6' 11" (2 108)					
6' 10" (2 083)					
6' 9 1/2" (2 070)					
7' 3" (2 210)					
7' 2" (2 184)					
7' 1 1/2" (2 172)					
8' 3" (2 515)					
8' 2" (2 489)					
8' 1 1/2" (2 477)					

NOTES:

- Masonry dimensions include the use of Pella® Aluminum Traditional Trim (#72D6) for clad products and brickmould for wood products.

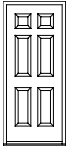

Entry Doors



Door/Transom Composites

Scale 1/8" = 1' 0"

SP6-28

2' 8" x 6' 8" In-Swing Doors with Rectangular and Elliptical Transoms

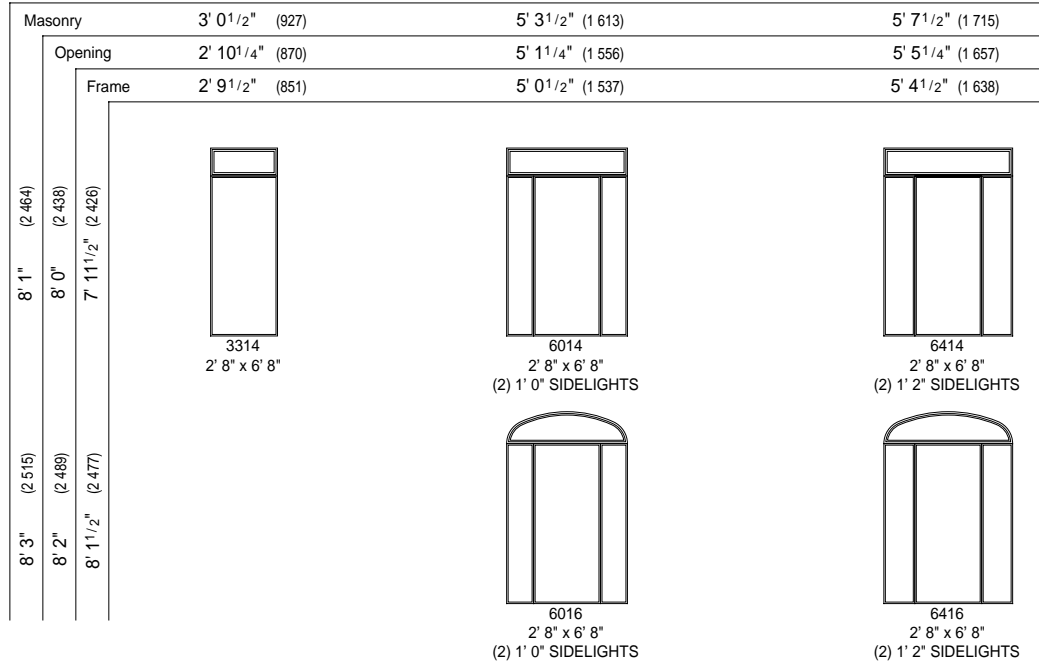

2' 8" x 6' 8" In-Swing Doors with Circlehead and Arch Head Transoms

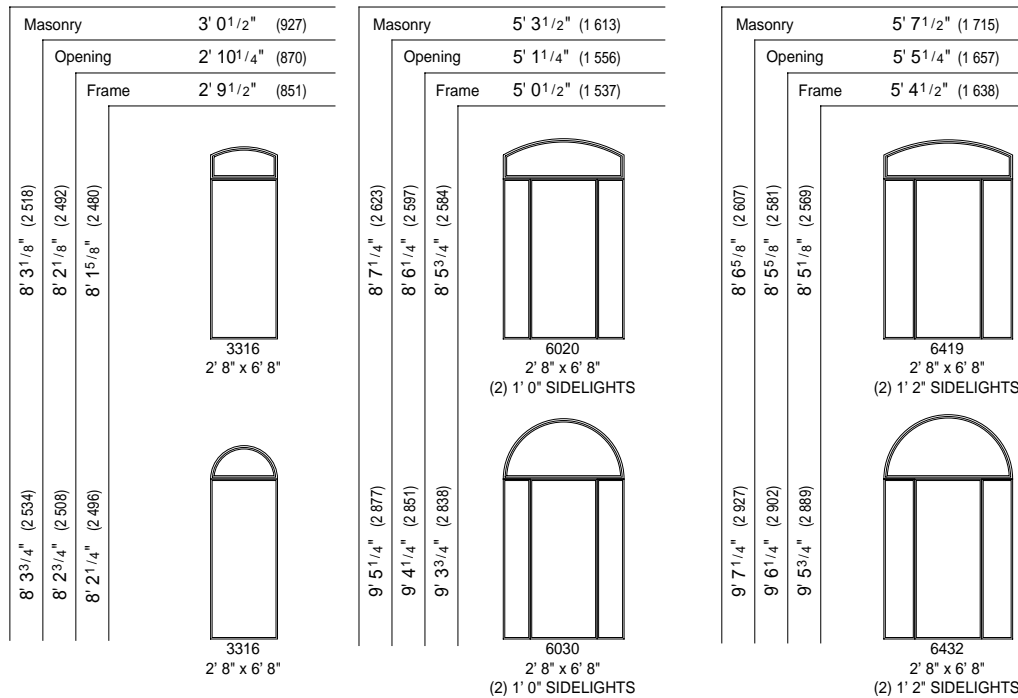

NOTES:

- Masonry dimensions include the use of Pella® Aluminum Traditional Trim (#72D6) for clad products and brickmould for wood products.



Entry Doors

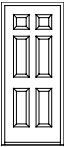

Scale 1/8" = 1' 0"

Door/Transom Composites

SP6-29

2' 8" x 7'0" In-Swing Doors with Rectangular and Elliptical Transoms

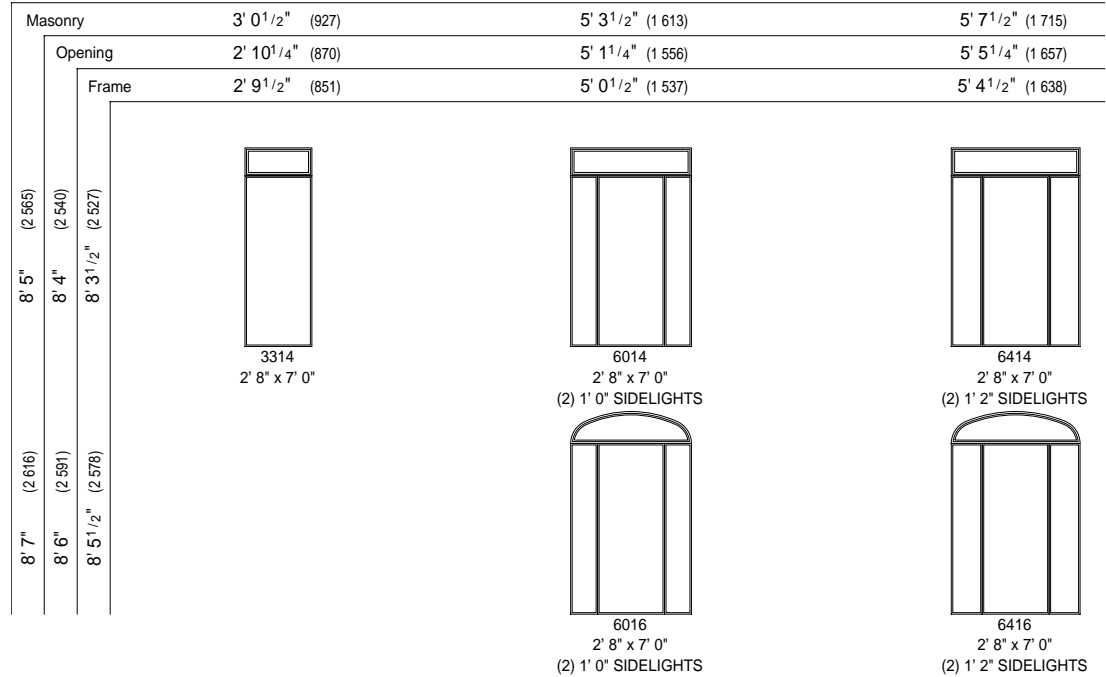

2' 8" x 7' 0" In-Swing Doors with Circlehead and Arch Head Transoms

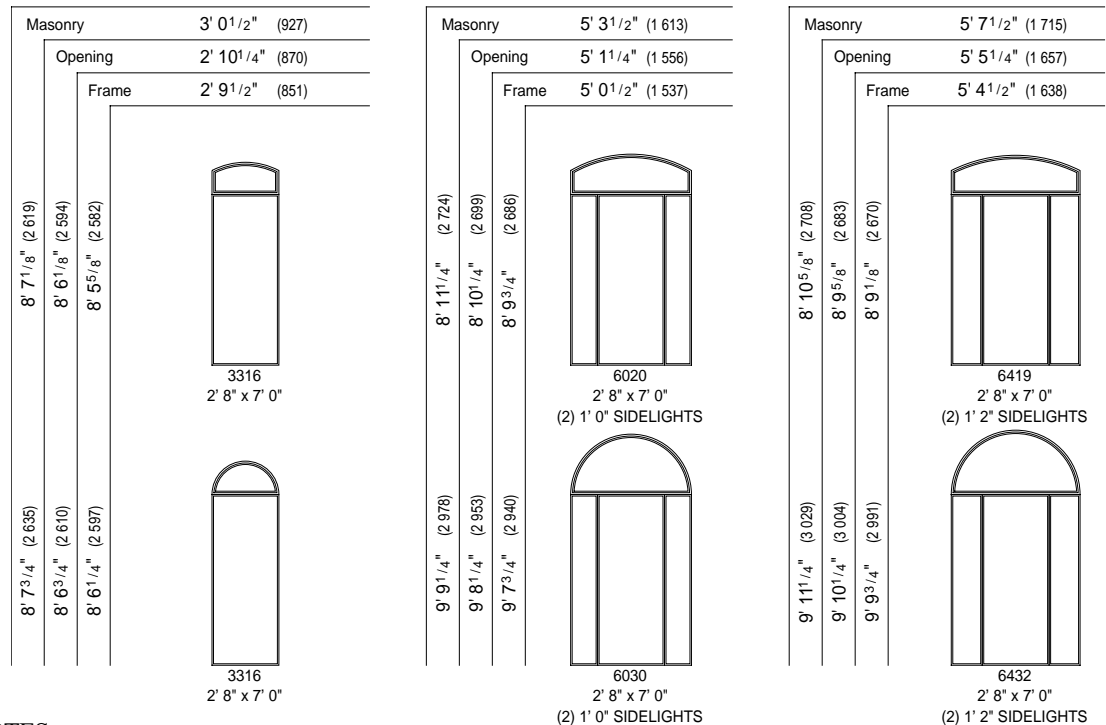

NOTES:

- Masonry dimensions include the use of Pella® Aluminum Traditional Trim (#72D6) for clad products and brickmould for wood products.

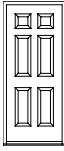

Entry Doors



Door/Transom Composites

Scale 1/8" = 1' 0"

SP6-30

2' 8" x 8' 0" In-Swing Doors with Rectangular and Elliptical Transoms

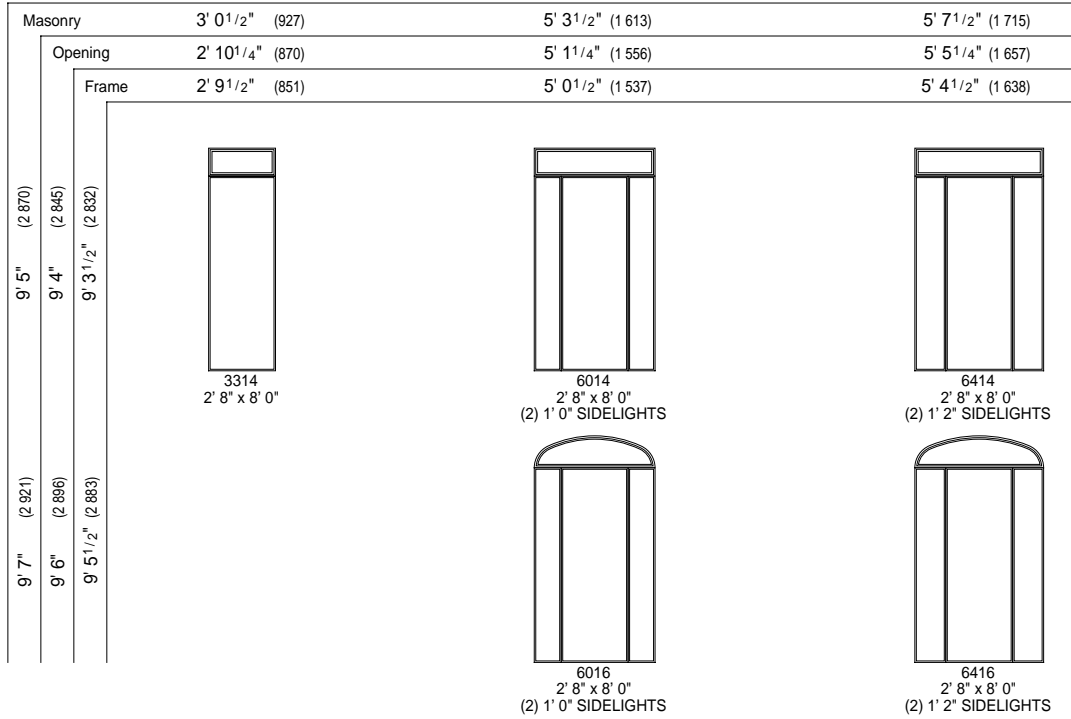

2' 8" x 8' 0" In-Swing Doors with Circlehead and Arch Head Transoms

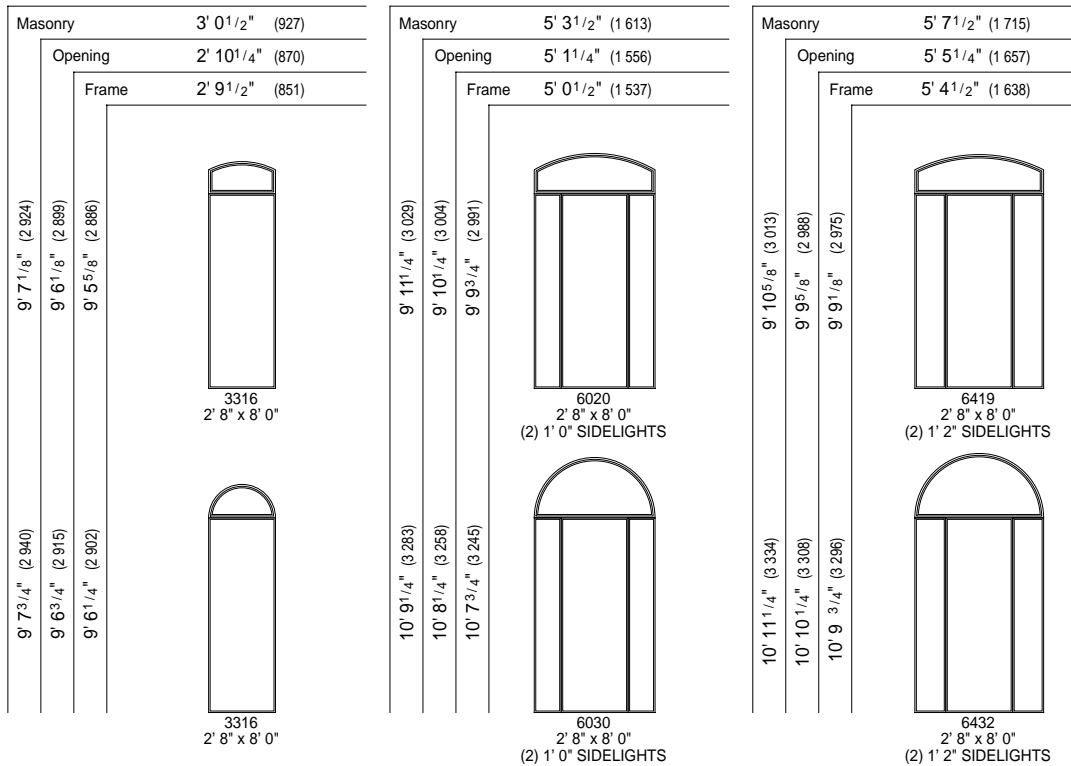

NOTES:
 • Masonry dimensions include the use of Pella® Aluminum Traditional Trim (#72D6) for clad products and brickmould for wood products.



Entry Doors

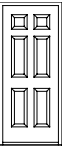

Scale 1/8" = 1' 0"

Door/Transom Composites

SP6-31

3' 0" x 6' 8" In-Swing Doors with Rectangular and Elliptical Transoms

Masonry	3' 4 1/2" (1 029)	5' 7 1/2" (1 715)	5' 11 1/2" (1 816)
Opening	3' 2 1/4" (972)	5' 5 1/4" (1 657)	5' 9 1/4" (1 759)
Frame	3' 1 1/2" (953)	5' 4 1/2" (1 638)	5' 8 1/2" (1 740)

8' 1" (2 464)		8' 0" (2 438)		7' 11 1/2" (2 426)	
	3714		6414		6814
	3' 0" x 6' 8"		3' 0" x 6' 8"		3' 0" x 6' 8"
			(2) 1' 0" SIDELIGHTS		(2) 1' 2" SIDELIGHTS

8' 3" (2 515)		8' 2" (2 489)		8' 1 1/2" (2 477)	
	6416		6416		6816
	3' 0" x 6' 8"		3' 0" x 6' 8"		3' 0" x 6' 8"
			(2) 1' 0" SIDELIGHTS		(2) 1' 2" SIDELIGHTS

3' 0" x 6' 8" In-Swing Doors with Circlehead and Arch Head Transoms

Masonry	3' 4 1/2" (1 029)	5' 7 1/2" (1 715)	5' 11 1/2" (1 816)
Opening	3' 2 1/4" (972)	5' 5 1/4" (1 657)	5' 9 1/4" (1 759)
Frame	3' 1 1/2" (953)	5' 4 1/2" (1 638)	5' 8 1/2" (1 740)

8' 3 1/2" (2 527)		8' 2 1/2" (2 502)		8' 2" (2 489)	
	3716		6419		6820
	3' 0" x 6' 8"		3' 0" x 6' 8"		3' 0" x 6' 8"
			(2) 1' 0" SIDELIGHTS		(2) 1' 2" SIDELIGHTS

8' 5 3/4" (2 584)		8' 6 5/8" (2 607)		8' 7 3/4" (2 635)	
	3718		6432		6834
	3' 0" x 6' 8"		3' 0" x 6' 8"		3' 0" x 6' 8"
			(2) 1' 0" SIDELIGHTS		(2) 1' 2" SIDELIGHTS

8' 4 3/4" (2 559)		8' 5 5/8" (2 581)		8' 6 3/4" (2 610)	
	6419		6419		6820
	3' 0" x 6' 8"		3' 0" x 6' 8"		3' 0" x 6' 8"
			(2) 1' 0" SIDELIGHTS		(2) 1' 2" SIDELIGHTS

8' 4 1/4" (2 546)		8' 5 1/8" (2 569)		8' 6 1/4" (2 597)	
	6432		6432		6834
	3' 0" x 6' 8"		3' 0" x 6' 8"		3' 0" x 6' 8"
			(2) 1' 0" SIDELIGHTS		(2) 1' 2" SIDELIGHTS

NOTES:
 • Masonry dimensions include the use of Pella® Aluminum Traditional Trim (#72D6) for clad products and brickmould for wood products.

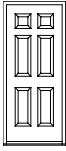

Entry Doors



Door/Transom Composites

Scale 1/8" = 1' 0"

SP6-32

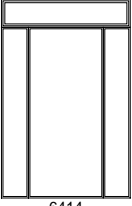
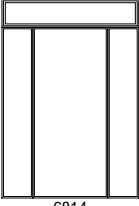
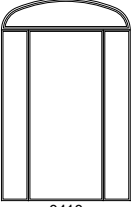
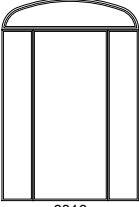

3' 0" x 7' 0" In-Swing Doors with Rectangular and Elliptical Transoms

Masonry	3' 4 1/2" (1 029)	5' 7 1/2" (1 715)	5' 11 1/2" (1 816)
Opening	3' 2 1/4" (972)	5' 5 1/4" (1 657)	5' 9 1/4" (1 759)
Frame	3' 1 1/2" (953)	5' 4 1/2" (1 638)	5' 8 1/2" (1 740)

8' 5" (2 565)		3714 3' 0" x 7' 0"
8' 4" (2 540)		6414 3' 0" x 7' 0" (2) 1' 0" SIDELIGHTS
8' 3 1/2" (2 527)		6814 3' 0" x 7' 0" (2) 1' 2" SIDELIGHTS
8' 7" (2 616)		6416 3' 0" x 7' 0" (2) 1' 0" SIDELIGHTS
8' 6" (2 591)		6816 3' 0" x 7' 0" (2) 1' 2" SIDELIGHTS
8' 5 1/2" (2 578)		

3' 0" x 7' 0" In-Swing Doors with Circlehead & Arch Head Transoms

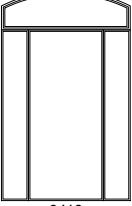
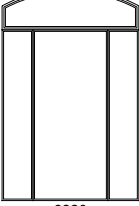
Masonry	3' 4 1/2" (1 029)	5' 7 1/2" (1 715)	5' 11 1/2" (1 816)
Opening	3' 2 1/4" (972)	5' 5 1/4" (1 657)	5' 9 1/4" (1 759)
Frame	3' 1 1/2" (953)	5' 4 1/2" (1 638)	5' 8 1/2" (1 740)

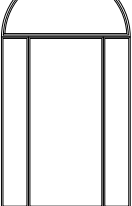
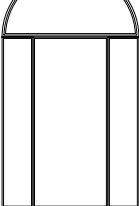
8' 7 1/2" (2 629)		3716 3' 0" x 7' 0"
8' 6 1/2" (2 604)		6419 3' 0" x 7' 0" (2) 1' 0" SIDELIGHTS
8' 6" (2 591)		6820 3' 0" x 7' 0" (2) 1' 2" SIDELIGHTS
8' 9 3/4" (2 686)		3718 3' 0" x 7' 0"
8' 8 3/4" (2 661)		6432 3' 0" x 7' 0" (2) 1' 0" SIDELIGHTS
8' 8 1/4" (2 648)		6834 3' 0" x 7' 0" (2) 1' 2" SIDELIGHTS

NOTES:
 • Masonry dimensions include the use of Pella® Aluminum Traditional Trim (#72D6) for clad products and brickmould for wood products.



Entry Doors

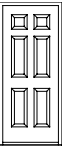

Scale 1/8" = 1' 0"

Door/Transom Composites

SP6-33

NOTES:
 • Masonry dimensions include the use of Pella® Aluminum Traditional Trim (#72D6) for clad products and brickmould for wood products.

3' 0" x 8' 0" In-Swing Doors with Rectangular and Elliptical Transoms

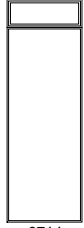
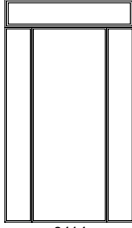
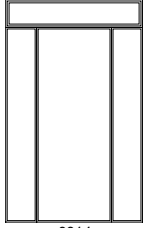
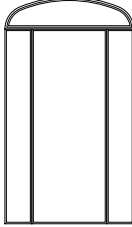
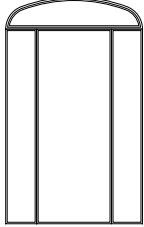
Masonry	3' 4 1/2" (1 029)	5' 7 1/2" (1 715)	5' 11 1/2" (1 816)
Opening	3' 2 1/4" (972)	5' 5 1/4" (1 657)	5' 9 1/4" (1 759)
Frame	3' 1 1/2" (953)	5' 4 1/2" (1 638)	5' 8 1/2" (1 740)
9' 5" (2 870)			
9' 6" (2 896)	3714 3' 0" x 8' 0"	6414 3' 0" x 8' 0" (2) 1' 0" SIDELIGHTS	6814 3' 0" x 8' 0" (2) 1' 2" SIDELIGHTS
9' 7" (2 921)			
9' 5 1/2" (2 883)		6416 3' 0" x 8' 0" (2) 1' 0" SIDELIGHTS	6816 3' 0" x 8' 0" (2) 1' 2" SIDELIGHTS

3' 0" x 8' 0" In-Swing Doors with Circlehead & Arch Head Transoms

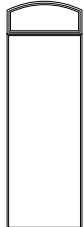
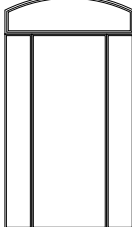
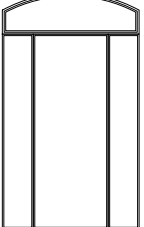
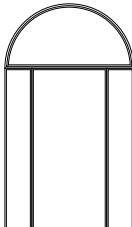
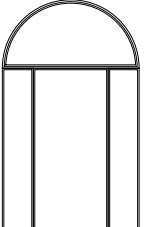
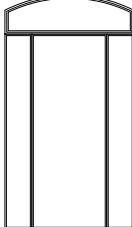
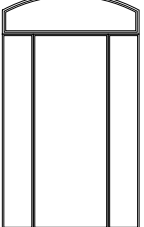
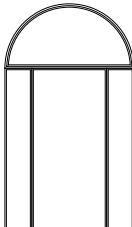
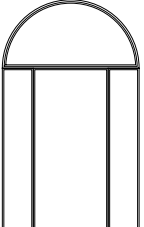
Masonry	3' 4 1/2" (1 029)	5' 7 1/2" (1 715)	5' 11 1/2" (1 816)
Opening	3' 2 1/4" (972)	5' 5 1/4" (1 657)	5' 9 1/4" (1 759)
Frame	3' 1 1/2" (953)	5' 4 1/2" (1 638)	5' 8 1/2" (1 740)
9' 7 1/2" (2 934)			
9' 6 1/2" (2 908)	3716 3' 0" x 8' 0"	6419 3' 0" x 8' 0" (2) 1' 0" SIDELIGHTS	6820 3' 0" x 8' 0" (2) 1' 2" SIDELIGHTS
9' 6" (2 896)			
9' 9 3/4" (2 991)		6432 3' 0" x 8' 0" (2) 1' 0" SIDELIGHTS	6834 3' 0" x 8' 0" (2) 1' 2" SIDELIGHTS
9' 8 3/4" (2 965)			
9' 8 1/4" (2 963)			
10' 11 1/4" (3 334)			
10' 10 1/4" (3 321)		6419 3' 0" x 8' 0" (2) 1' 0" SIDELIGHTS	6820 3' 0" x 8' 0" (2) 1' 2" SIDELIGHTS
10' 9 3/4" (3 296)			
11' 11 1/4" (3 385)			
11' 10 1/4" (3 359)		6432 3' 0" x 8' 0" (2) 1' 0" SIDELIGHTS	6834 3' 0" x 8' 0" (2) 1' 2" SIDELIGHTS
10' 11 3/4" (3 346)			

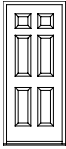

Entry Doors



Door/Transom Composites

Scale 1/8" = 1' 0"

SP6-34

2' 8" x 6' 8" Out-Swing Doors with Transoms

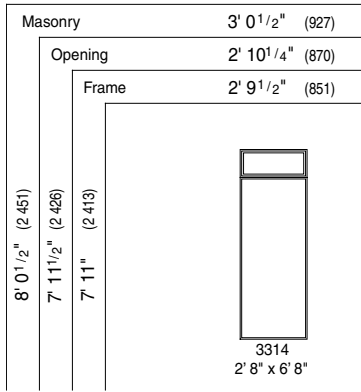

2' 8" x 7' 0" Out-Swing Doors with Transoms

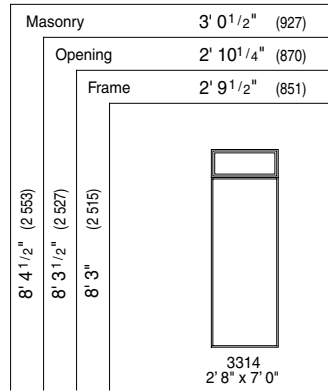

2' 8" x 8' 0" Out-Swing Doors with Transoms

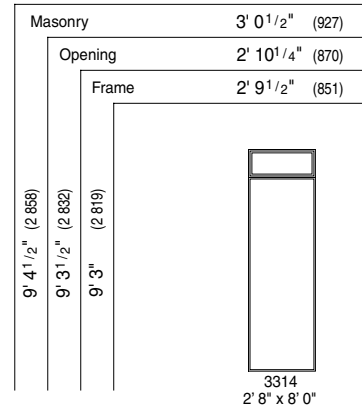

2' 8" x 6' 8" Out-Swing Doors with Circlehead & Arch Head Transoms

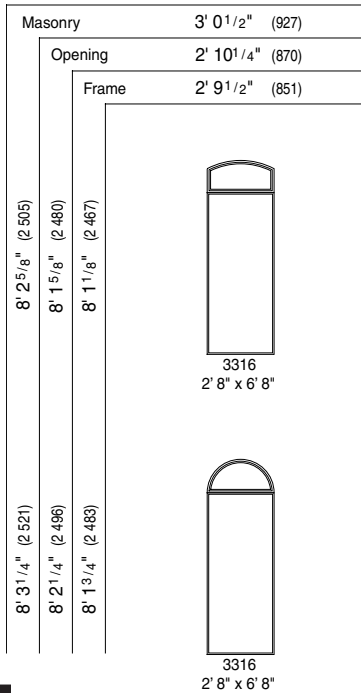

2' 8" x 7' 0" Out-Swing Doors with Circlehead & Arch Head Transoms

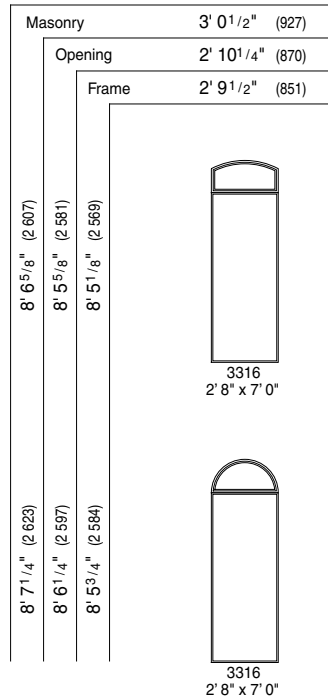

2' 8" x 8' 0" Out-Swing Doors with Circlehead & Arch Head Transoms

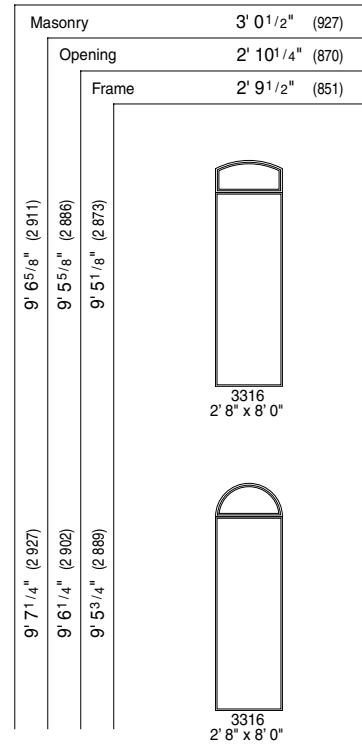

NOTES:
 • Masonry dimensions include the use of Pella® brickmould for wood products.



Entry Doors

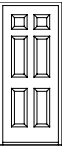

Scale 1/8" = 1' 0"

Door/Transom Composites

SP6-35

3' 0" x 6' 8" Out-Swing Doors with Transoms

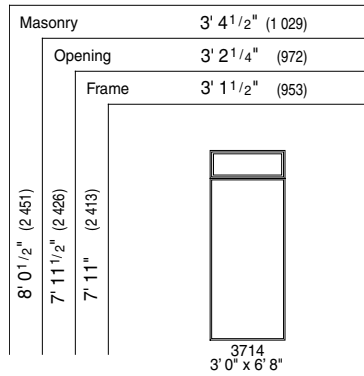

3' 0" x 7' 0" Out-Swing Doors with Transoms

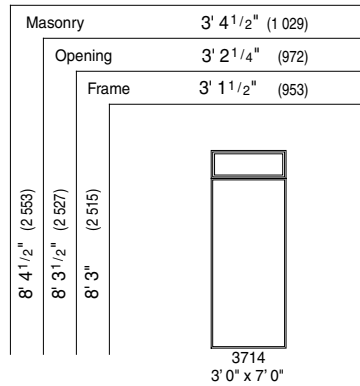

3' 0" x 8' 0" Out-Swing Doors with Transoms

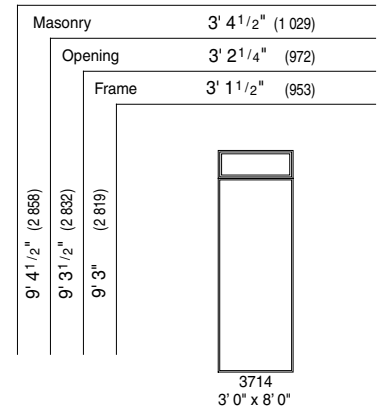

3' 0" x 6' 8" Out-Swing Doors with Circlehead & Arch Head Transoms

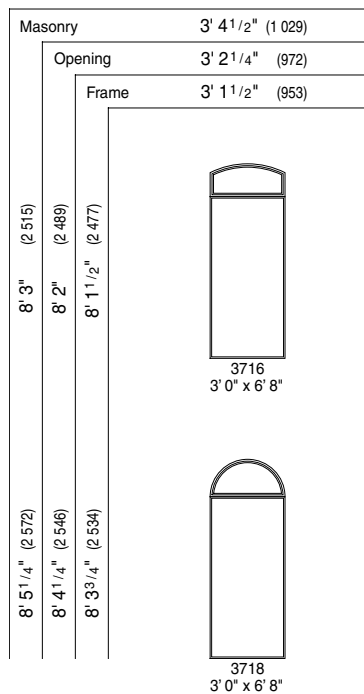

3' 0" x 7' 0" Out-Swing Doors with Circlehead & Arch Head Transoms

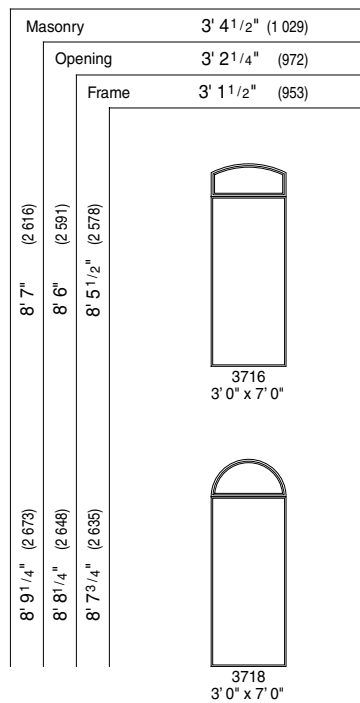

3' 0" x 8' 0" Out-Swing Doors with Circlehead & Arch Head Transoms

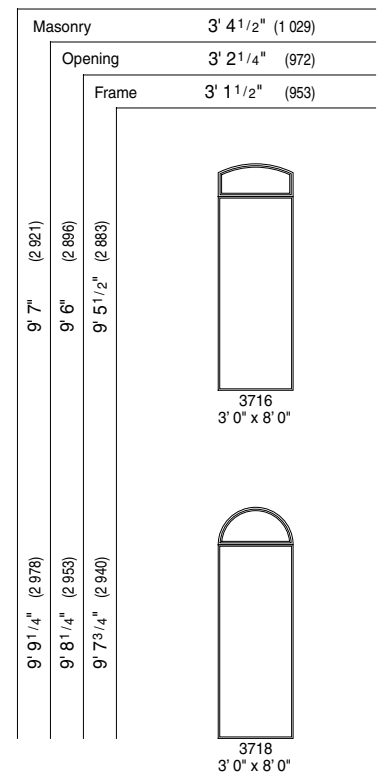

NOTES:

- Masonry dimensions include the use of Pella® brickmould for wood products.